

## TPC215-RK3588

### 21.5" All-in-one Panel PC



#### Product Brief





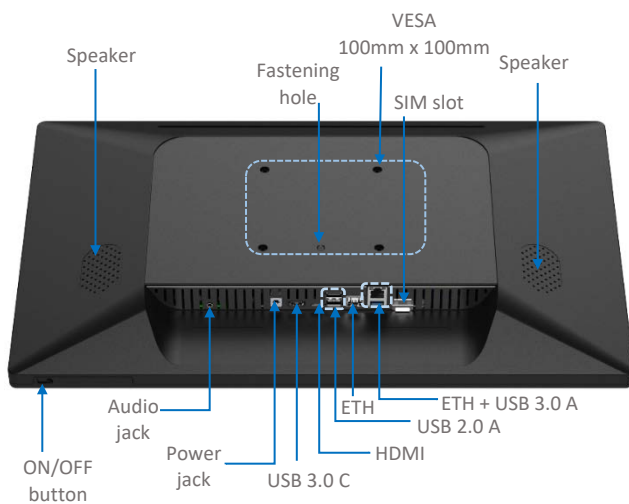

Vantron TPC215-RK3588 is a 21.5" desktop all-in-one panel PC, powered by RK3588 octa-core high-performance processor. It features a 21.5-inch 10-point PCAP touchscreen monitor with 16:9 aspect ratio and runs Android 12 operating system with Linux distributions available. TPC215-RK3588 offers rich interfaces for connection of different peripherals and displays. It is very suitable to be applied in self-service kiosks and multi-media terminals. The VESA pattern allows users to mount and maintain the device more flexibly for industrial control.

Vantron TPC series all-in-one panel PCs offer an overall solution that integrates the touchscreen monitor, display, processor, and software operating system, making them a first choice in IoT applications.

#### Exterior and Features



#### TPC215-RK3588

-  RK3588 Octa-core high-performance processor
-  Android 12 and later, Linux distributions available
-  21.5-inch TFT LCD, 10-point PCAP touch screen
-  5MP front camera, optional facial recognition algorithm
-  Dual-band Wi-Fi, Wi-Fi 6 supported
-  Dual gigabit Ethernet ports
-  Sleek appearance, flexible installation (horizontal, vertical, desktop, wall mounting, floor mounting)

**TPC215-RK3588 21.5" All-in-one Panel PC Datasheet**

TPC215-RK3588				
<b>System</b>	CPU	Rockchip RK3588, Quad-core ARM Cortex A76 + Quad-core ARM Cortex A55 processor, 2.4GHz (Max.)		
	Memory	8GB (Optional: 4GB)		
	Storage	32GB (Optional: 64GB)	Optional: Expansion by an M.2 M-Key/B-Key	
<b>Communication</b>	Ethernet	2 x RJ45, 10/100/1000Mbps		
	Wi-Fi & BT	2.4GHz & 5GHz 802.11 a/b/g/n/ac/ax + BT 5.0 or later		
	Cellular	Optional: Expansion by an M.2 B-Key for 4G LTE (CAT 4)		
<b>Media</b>	Display	21.5-inch TFT LCD	Contrast ratio: 1000:1	
		Resolution: 1920 x 1080 @60Hz	Aspect ratio: 16:9	
		Brightness: 250 nits	Viewing angle: 89/89/89/89 (U/D/L/R)	
	External display	1 x HDMI, up to 4K @60Hz		
	TP	10-point PCAP touch screen	Surface hardness: 6H	
		Surface treatment: Anti-fingerprint	Cover lens: At least IK03 rated	
		Optional: Anti-glare & anti-reflection	Light transmittance ratio: > 85%	
Camera	Front camera, 5MP			
Audio	1 x 3.5mm combo audio jack	Built-in dual-track speakers (2 x 2W)		
<b>I/Os</b>	USB	1 x USB 3.0 Type-C	1 x USB 3.0 Type-A	
		2 x USB 2.0 Type-A		
	RTC	Supported, scheduled on/off supported		
	WDT	Supported		
	SIM slot	1 x SIM slot		
Expansion	1 x M.2 M-Key 2260/2280, PCIe 3.0 x 4, for SSD expansion			
	1 x M.2 B-Key 2242/3052, USB3.0/SATA3.0, for SSD/4G LTE expansion			
<b>System control</b>	Button	1 x ON/OFF button		
	LED indicator	1 x LED indicator (Power and system status)		
<b>Software</b>	OS	Android 12 or later	Optional: Debian 11, Ubuntu 20.04	
	Device management platform	BlueSphere MDM (Android version only)		
	OTA tool	BlueSphere OTA		
<b>Power</b>	Input	12V/24V DC	1 x Power jack	
	Consumption	< 35W		
<b>Mechanical</b>	Dimensions	526mm x 322.7mm x 52.9mm		
	Installation	VESA mounting (100mm x 100mm)		
	Protective features	IP54 (front side only)		
	Heat dissipation	Fanless (Heatsink, housing)		
<b>Environment condition</b>	Temperature	Operating: 0°C ~ +40°C	Storage: -20°C ~ +60°C	
	Humidity	RH 0-90% (Non-condensing)		
	Touch life	> 50 million touches		
	Certification	CCC, FCC		

## Product Outlines

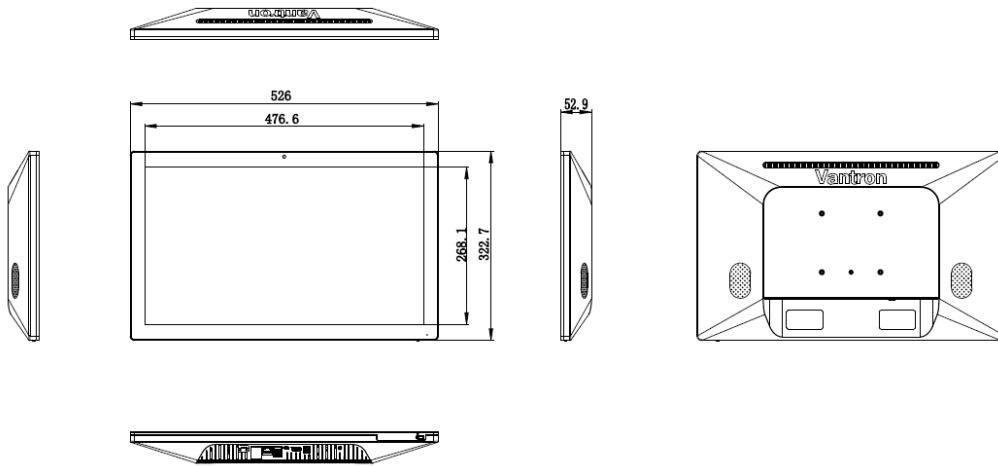

## Ordering Information

Ordering No.	Memory	Storage	Front camera	Wi-Fi & BT	Ethernet	4G LTE
TPC215-RK3588-L	4GB	32GB	Yes	Yes	Yes	-
TPC215-RK3588-L4	4GB	32GB	Yes	Yes	Yes	Yes
TPC215-RK3588-H	8GB	64GB	Yes	Yes	Yes	-
TPC215-RK3588-H4	8GB	64GB	Yes	Yes	Yes	Yes

\* More variants are available, please contact the sales executive for details.

Packing List	
TPC215-RK3588 all-in-one panel PC	1
12V 5A DC adapter	1
AC power cable (US)	1

Since its establishment in 2002 by two Silicon Valley entrepreneurs, Vantron Technology has been at the forefront of the connected IoT devices and IoT platform solutions. Today, Vantron boasts a global customer base that includes several Fortune 500 companies. Its product lines cover edge intelligent hardware, IoT communication devices, industrial displays and BlueSphere cloud device management platform.

Vantron's intelligent display systems are comprised of mobile PCs and touchscreen monitors that deliver enhanced device performance and exceptional human-machine interactive experience. The mobile PCs are powered by industry-leading brands such as Rockchip, NXP, MediaTek, and Intel. The touchscreen monitors offer flexible installation options to cater to various application scenarios. Moreover, the displays are built to excel in harsh environments thanks to advanced features like waterproofing, dustproofing, and shatter resistance.