

M10R1-RK35

10" Rugged Industrial Tablet



Product Brief

Vantron M10R1-RK35 is a 10-inch high-performance rugged tablet, designed to handle demanding tasks with ease. It is powered by Rockchip RK3588S octa-core processor, combined with ARM Mali-G610 MP4 GPU for 3D/2D graphics acceleration and a 6 TOPS NPU for industrial applications such as healthcare, plant walk-down, law enforcement patrol, and prison automation.







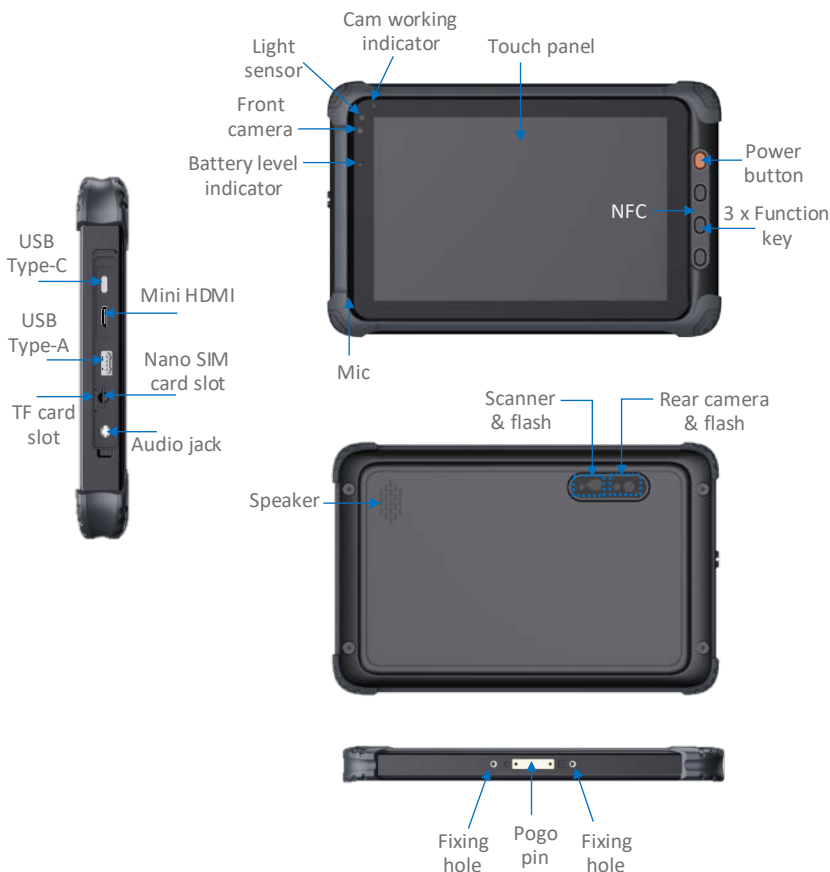

M10R1-RK35 features a resolution of 1920 x 1200 and a brightness of 600 nits to provide clear visuals even in bright sunlight or harsh lighting conditions. It is IP65 rated for water and dust resistance. Additionally, it has also been drop-tested from a height of 1.5m on all 6 sides, ensuring that it can withstand accidental drops and bumps without skipping a beat.

M10R1-RK35 offers a pogo pin header to allow users to connect additional peripherals with ease. It supports up to 60W PD charging, ensuring quick and efficient charging when needed. Moreover, the built-in scanner enables it to be applied across diverse industries.

Exterior and Features



M10R1-RK35

-  Automotive-grade chip
-  Front & rear cameras, built-in barcode scanner
-  NFC at 13.5MHz
-  IPS panel, 1920 x 1200, 600 nits
-  6000mAh Battery, lasting for 8 hours
-  IP65, 1.5m drop test on 6 sides
-  Pogo pin for flexible expansion
-  USB Type-C, data transmission & 60W PD supported

M10R1-RK35 10" Rugged Industrial Tablet Datasheet

M10R1-RK35				
System	CPU	Rockchip RK3588S Quad-core ARM Cortex-A76 MPCore processor + Quad-core ARM Cortex-A55 MPCore processor, Max. 2.4GHz		
	GPU	ARM Mali-G610 MP4, Max. 1GHz		
	NPU	6 TOPs		
	Memory	4GB LPDDR4		
	Storage	64GB eMMC V5.1	1 x M.2 M-Key (2242) SATA/NVMe for SSD	
Communication	Wi-Fi & Bluetooth	Wi-Fi 802.11 a/b/g/n/ac/ax + BT 5.1		
	Cellular	2G/3G/4G, LTE CAT 4		
	GNSS	GPS + BeiDou + GLONASS + Galileo, A-GPS supported		
	NFC	Supported, 13.5MHz		
Media	Display	10" 16:10 IPS TFT LCD		
		Resolution	1920 x 1200	
		Brightness	600 nits	
		Contrast ratio	1000:1	
	TP	10-point G + G PCAP touch screen		
		Finishing process: Toughening	Surface hardness: 6H	
	Camera	Front camera	5MP, fixed focus, with a working indicator	
		Rear camera	8MP, auto focus, with a flash	
Audio	1 x 4Ω/2w speaker	1 x Mic		
	1 x 3.5mm combo audio jack			
I/Os	USB	1 x USB 2.0 Type-A	1 x USB 3.0 Type-C	
	Built-in barcode scanner	Bar width	> 8Mil	
		Pixel	> 640 x 480	
	Extended display	1 x Mini HDMI		
	Pogo pin	2 x 10 pin, supporting CAN J1939, USB 3.0, 100Mbps Ethernet RJ45, Audio Jack, RS232/RS485 Combo, TJA1100HN 100Base-T1 PHY		
	SIM card slot	1 x Nano SIM slot		
	TF slot	1 x TF slot (up to 128GB)		
Security	1 x TPM 2.0 (Optional)			
System Control	Sensor	1 x Light sensor	1 x Gyro-sensor	
		1 x G-sensor	1 x Geomagnetic sensor	
	Button	1 x Power button	3 x Function button	
		1 x Volume +/- button		
LED indicator	1 x Camera working indicator			
	1 x Battery level indicator (Low power (≤15%): Red; 0~99% while charging: Amber; Full charge: Green)			
Software	OS	Android 13, Linux Yocto + QT		
Power	Input	USB Type-C power input, 5V/3A, 9V/3A, 12V/3A, 20V/3A, 60W PD supported		
	Battery	6000mAh/7.6V, 8 hours working time*		
Mechanical	Material	PC, ABS		
	Dimensions	293.6mm x 191mm x 29.1mm		
	Net weight	1300g		
Performance Standard	IP rating	IP65		
	Drop testing	Drop from 1.5m onto concrete surfaces on 6 sides		
	MIL-STD-810H	Vibration, thermal shock, solar radiation, liquid pollution		
	Battery testing	UN38.3 MSDS Sea/Freight, IEC62133		
Environment Condition	Temperature	Operating: 0°C ~+60°C	Storage: -30°C ~+70°C	
	Humidity	20%~80% RH (Non-condensing)		
	Certification	MIL-STD-810H	FCC (FCC Part 15 Class B)	
ISED, CE		ESD (Contact: ±4KV, Air: ±8KV)		

* Source: Test with 1080p video play at 50% volume and 200 nits brightness.

Product Outlines

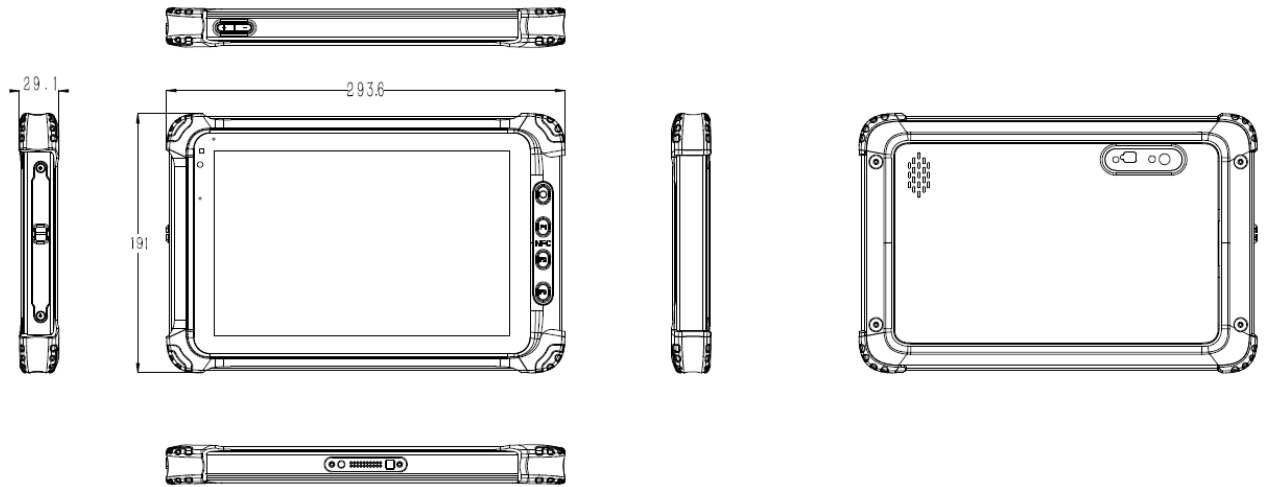

Ordering Information

Ordering No.	Memory	Storage	Features
M10R1-RK35	4GB	64GB	USB-A, USB-C, Mini HDMI, barcode scanner, Android 13, Linux Yocto +QT

Packing list	
M10R1-RK35 Industrial tablet	1
USB power adapter	1
USB Type-C cable	1
Qualified certificate	1

Since its establishment in 2002 by two Silicon Valley entrepreneurs, Vantron Technology has been at the forefront of the connected IoT devices and IoT platform solutions. Today, Vantron boasts a global customer base that includes several Fortune Global 500 companies. Its product lines cover edge intelligent hardware, IoT communication devices, industrial displays and BlueSphere cloud platforms.

Vantron's intelligent display systems are comprised of industrial tablets, touchscreen monitors, and all-in-one panel PCs that deliver enhanced device performance and exceptional human-machine interactive experience. The industrial tablets are powered by industry-leading brands such as Rockchip, NXP, MediaTek, and Intel. The touchscreen monitors offer flexible installation options to cater to various application scenarios. The all-in-one panel PCs offer an overall solution that integrates the touchscreen monitor, display, processor, and operating system. Moreover, the displays are built to excel in harsh environments thanks to advanced features like waterproofing, dustproofing, and shatter resistance.