

# IBOX3588 Edge AI

## Embedded Industrial Computer



### Product Brief

Vantron IBOX3588 Edge AI Embedded Industrial Computer is powered by Rockchip's latest flagship RK3588 AIoT chipset. The innovative chipset is equipped with an 8-core 64-bit CPU, an ARM Mali-G610 MP4 quad-core GPU, and a built-in AI acceleration NPU, providing 6 TOPS computing power. Furthermore, it supports mainstream deep learning frameworks to allow a wide range of AI-based applications. As technology continues to advance, there definitely will be a rising demand for AI-based products in the industrial control market, making IBOX3588 the ideal choice for businesses looking to stay ahead of the curve.





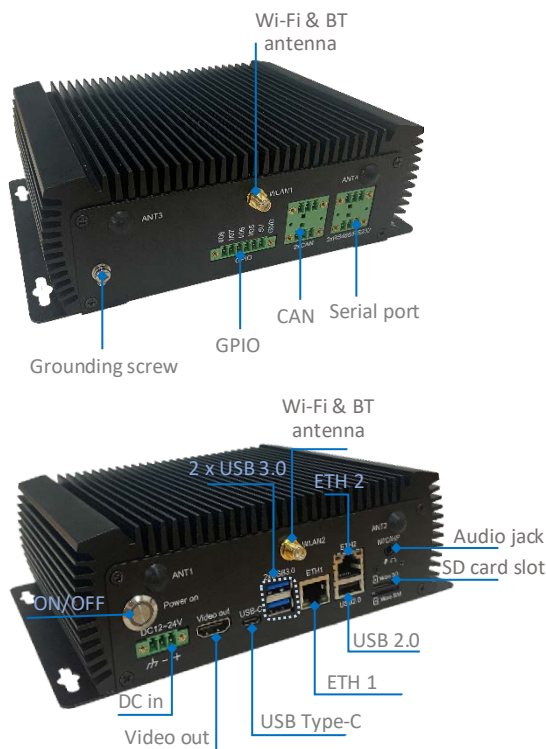

The industrial computer boasts an impressive array of features including two Gigabit Ethernet ports, support for Wi-Fi 6 and Bluetooth 5.1, ensuring the communication is uninterrupted. IBOX3588 also supports 8K video decoding and encoding for exceptional display performance.

IBOX3588 offers rich peripheral interfaces, allowing businesses to connect a wide range of peripherals for extended applications, making customers rest assured of a reliable and consistent user experience.

### Exterior and Features



#### IBOX3588

-  RK3588 Quad-core CA76 + Quad-core CA55 processor
-  High-quality video output
-  Rich interface for expansion
-  Wi-Fi (6)/BT/ETH for communication
-  Industrial-grade wide temperature design
-  High computing power
-  Deep learning acceleration
-  Industrial longevity

**IBOX3588 Edge AI Embedded Industrial Computer Datasheet**

IBOX3588		
<b>System</b>	CPU	Rockchip RK3588, Quad-core Cortex-A76 + Quad-core Cortex-A55, 2.4GHz (Max.)
	GPU	ARM Mali-G610 MC4, 1GHz (Max.)
	NPU	6 TOPS
	Memory	8GB LPDDR4, up to 32GB
	Storage	32GB eMMC, up to 128GB SSD supported by an M.2 M-Key/M.2 B-Key (256GB ~ 1TB)
<b>Communication</b>	Ethernet	2 x RJ45, 10/100/1000Mbps
	Cellular	4G/5G (Optional)
	Wi-Fi & Bluetooth	Wi-Fi 802.11 a/b/g/n/ac/ax + BT 5.1
<b>Media</b>	Display	1 x HDMI (4096 x 2160 @60Hz)
	Audio	1 x Combo audio jack
<b>I/Os</b>	USB	2 x USB 3.0 Host, Type-A
		1 x USB 2.0 Host, Type-A
		1 x USB 3.0 Type-C (OTG supported)
	Serial port	2 x RS232/RS485 (2 x 3 x 3.81mm, Baud rate: 115200)
	SIM slot	1 x SIM slot
	Micro SD slot	1 x Micro SD slot
	RTC	Supported
Watchdog	Supported	
<b>Expansion</b>	M.2 slot	1 x M.2 M-Key (2260/2280), PCIe 3.0 x 4, for SSD
		1 x M.2 B-Key (2242/3052), USB 3.0/SATA 3.0, for 4G/5G/SSD
	GPIO	4 x GPIO on the Phoenix terminal
	CAN	2 x CAN on the Phoenix terminal
<b>System Control</b>	Button	1 x ON/OFF button (long press to reset)
	LED	1 x LED indicator for power and system status
<b>Software</b>	OS	Android 12, Debian 11, Ubuntu 20.04
	Language	English (default), Chinese
	Device management platform	BlueSphere MDM (Android version only)
	OTA tool	BlueSphere OTA
<b>Power</b>	Input	1 x Power distribution block (12V/5A, 24V/3A)
<b>Mechanical</b>	Dimensions	200mm x 141mm x 63.2mm
	Enclosure	Aluminum + sheet metal, black
	Weight	1200g
	Shock test	IEC 60068-2-27
	IP rating	IP40
<b>Environment Condition</b>	Temperature	Operating: 0°C ~ +60°C (Optional: -20°C ~ +70°C) Storage: -40°C ~ +85°C
	Humidity	0~95% RH (non-condensing)
	Certification	FCC*, CCC, UL

\* IBOX3588 is FCC certified without cellular capability.

## Product Outlines

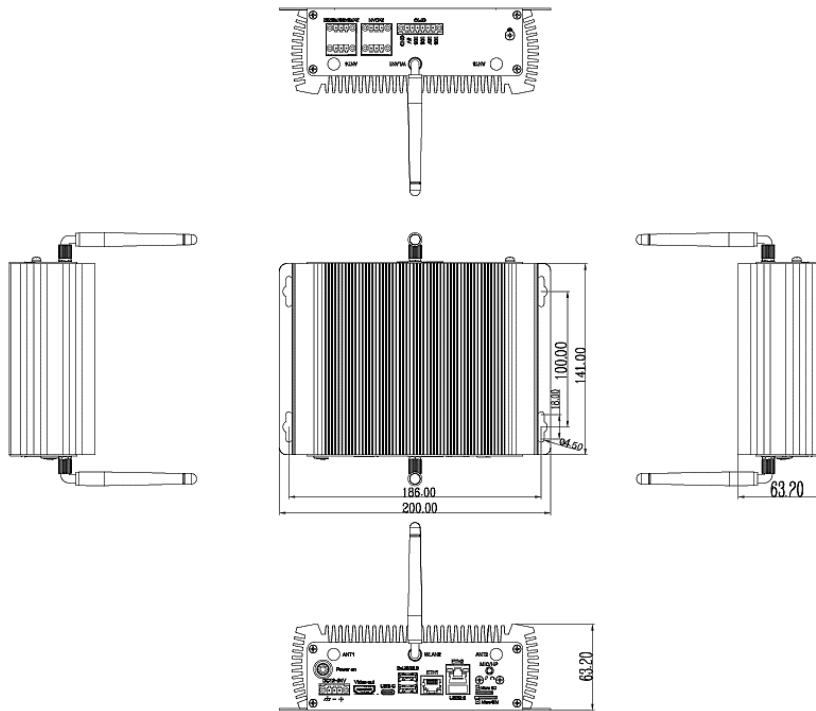

## Ordering Information

Ordering No.	Memory	Storage	AI accelerator	Wi-Fi & Bluetooth
IBOX3588-M	8GB	32GB	Yes	Yes
IBOX3588-H	8GB	32GB + 256GB (SSD)	Yes	Yes

\* More variants are available, please contact the sales executive for details.

Packing list	
IBOX3588 Embedded industrial computer	1
Wi-Fi & Bluetooth antenna	1

Optional accessories	
12V DC Adapter	1
Power cord	1
DC power connector	1

Since its establishment in 2002 by two Silicon Valley entrepreneurs, Vantron Technology has been at the forefront of the connected IoT devices and IoT platform solutions. Today, Vantron boasts a global customer base that includes Fortune Global 500 companies. Its product lines cover edge intelligent hardware, IoT communication devices, industrial displays, and BlueSphere cloud platforms.

With over 20 years of experience in R&D of intelligent edge hardware, Vantron has provided users with diverse embedded solutions featuring ARM and X86 architectures. Its offerings range from Linux to Windows, from embedded level to desktop level, and from gateways to servers. In addition, it provides users with system clipping, driver transplantation and other related services.