

# VT-SBC-SMARC-IMX91

## Computer-on-Module



### Product Brief





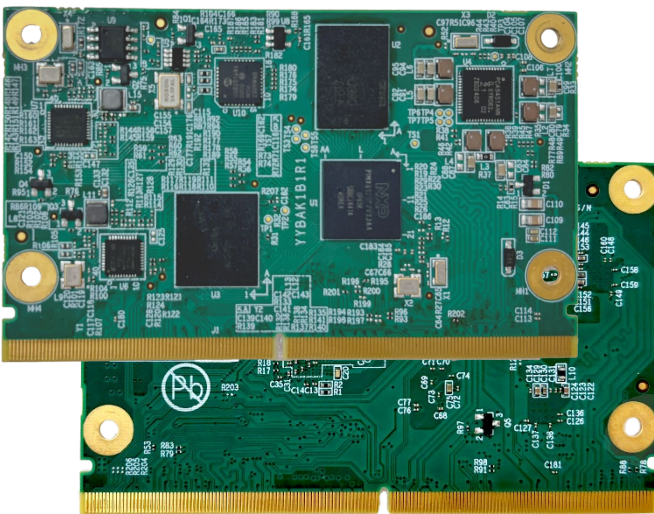

VT-SBC-SMARC-IMX91 Computer-on-Module (CoM) comes in a SMARC 2.1 form factor for easy integration into customers' development environment. It is powered by the NXP i.MX9131 single-core processor that integrates the scalable Arm Cortex-A55 core with a frequency up to 1.4GHz. Through integration of the features of the processor such as efficient machine learning acceleration, advanced security features, and optimal energy efficiency, the module is designed for smart home, IoT edge, industrial automation, and industrial applications.

The module supports rich interfaces, including high-speed serial buses like CAN, I<sup>2</sup>C, UART, and USB 2.0, as well as peripheral options such as GPIO and SDIO. With extensive scalability options, the module reduces the development time and costs for customers. In addition, the module offers two gigabit Ethernet for connectivity. It supports an industrial wide temperature range from -40°C to 85°C, making it applicable to harsh industrial environments.

### Exterior and Features



#### VT-SBC-SMARC-IMX91

-  NXP i.MX9131 ARM Cortex-A55 processor
-  512MB memory + 16GB storage
-  Rich I/O interfaces for flexible expansion
-  Gigabit Ethernet, 10/100/1000Mbps
-  Industrial Wide Temperature Range
-  Linux operating system supported
-  SMARC 2.1 form factor for flexible integration

**VT-SBC-SMARC-IMX91 Computer-on-Module Datasheet**

VT-SBC-SMARC-IMX91			
<b>System</b>	CPU	NXP i.MX9131, single-core ARM Cortex-A55 processor, up to 1.4 GHz	
	Memory	512MB LPDDR4, optional: 2GB/8GB	
	Storage	16GB eMMC 5.1	
	PMIC	PCA9451	
<b>Communication</b>	Ethernet	2 x Ethernet, 10/100/1000Mbps, PHY (YT8531H)	
<b>I/O</b>	USB	1 x USB 2.0 OTG	4 x USB 2.0 host
	UART	2 x UART for RS232/RS485	1 x UART for Debug (1.8V)
	CAN	2 x CAN	
	GPIO	40 x GPIO for GPIO/UART/SDIO/SPI	
	SDIO	1 x 4-bit SDIO for SD card	
	I <sup>2</sup> S	1 x I <sup>2</sup> S	
	I <sup>2</sup> C	2 x I <sup>2</sup> C	
	ADC	4 x ADC input	
	Watchdog Timer	Supported	
	RTC	Supported	
	<b>System Control</b>	Button	1 x Power button
<b>Power</b>	Input	5V/2A DC	
	Consumption	Max.: 6W (full load)	
<b>Software</b>	Operating system	Yocto, Other Linux distributions (support upon request)	
<b>Mechanical</b>	Dimensions	82mm x 50mm x 4.27mm (SMARC 2.1 form factor)	
<b>Environmental Condition</b>	Temperature	Operating: -40°C ~ +85°C	Storage: -40°C ~ +85°C
	Humidity	5%~95% RH (Non-condensing)	

**Block Diagram**

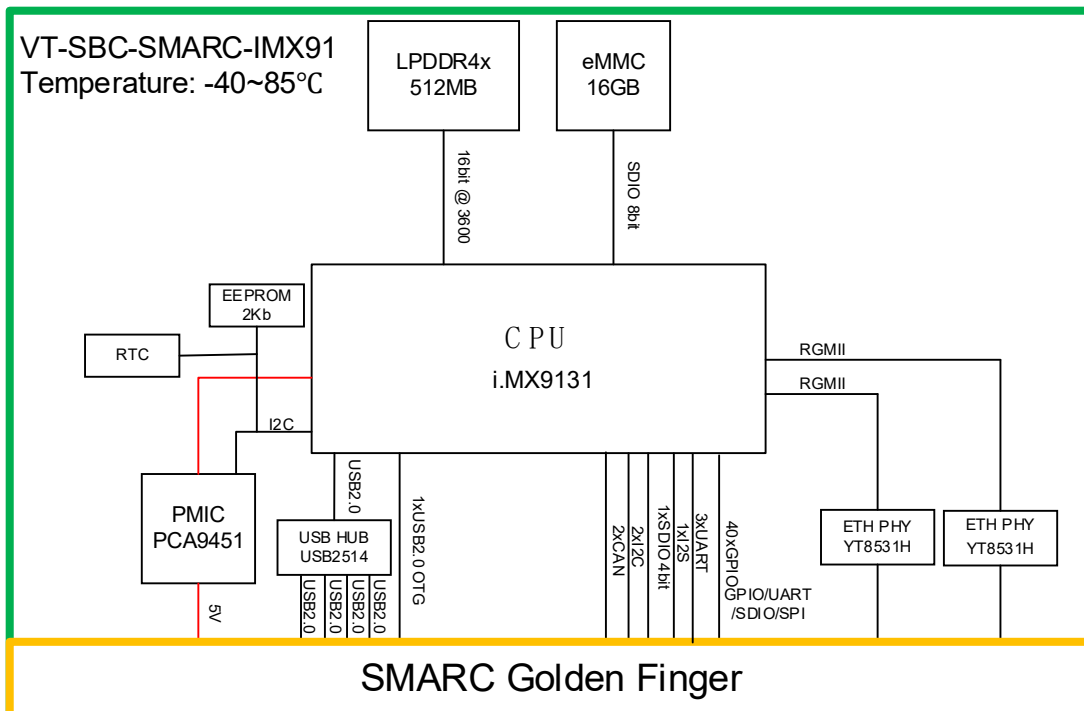

**Product Outlines**

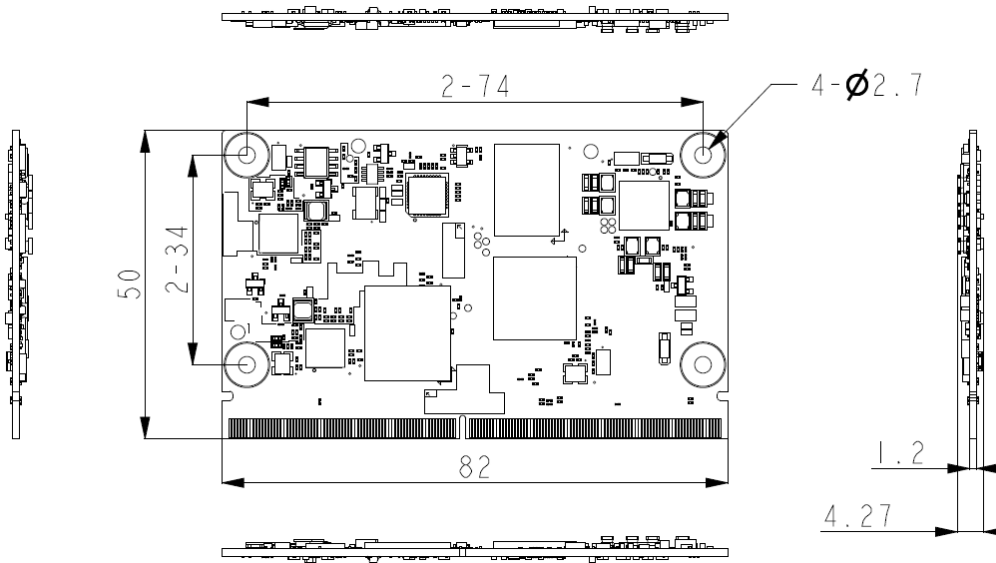

**Edge Connector Pinout**

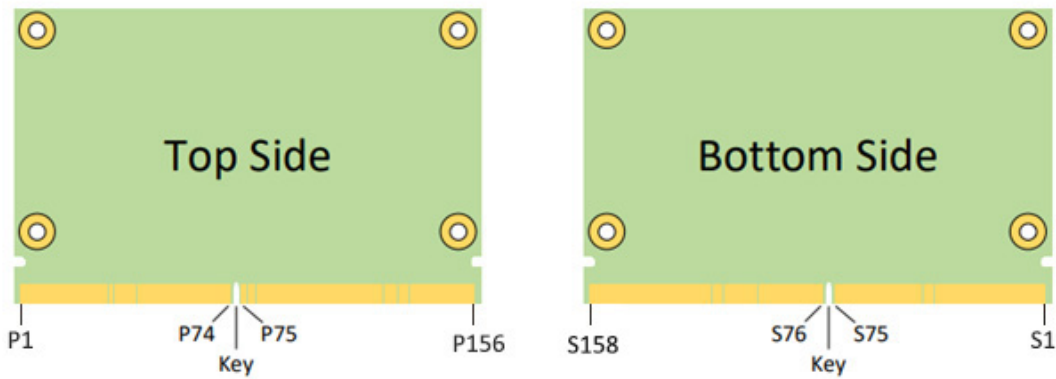

Primary (Top) Side	Function	I/O	I/O Level	Description
P1	NC	-	-	No connection
P2	NC	-	-	No connection
P3	NC	-	-	No connection
P4	NC	-	-	No connection
P5	NC	-	-	No connection
P6	NC	-	-	No connection
P7	NC	-	-	No connection
P8	NC	-	-	No connection
P9	NC	-	-	No connection
P10	NC	-	-	No connection
P11	NC	-	-	No connection
P12	NC	-	-	No connection
P13	NC	-	-	No connection
P14	NC	-	-	No connection
P15	NC	-	-	No connection
P16	NC	-	-	No connection

Primary (Top) Side	Function	I/O	I/O Level	Description
P17	NC	-	-	No connection
P18	NC	-	-	No connection
P19	ENETO_PHY_TRXN3	I/O		Differential Pair Signals for External Transformer
P20	ENETO_PHY_TRXP3	I/O		
P21	NC	-	-	No connection
P22	LED0_LINK1000	O	3.3V	Link Speed Indication LED for ENETO 1000Mbps
P23	ENETO_PHY_TRXN2	I/O		Differential Pair Signals for External Transformer
P24	ENETO_PHY_TRXP2	I/O		
P25	LED0_ACT	O	3.3V	Link / Activity Indication LED Driven Low on Link (10, 100 or 1000 Mbps) Blinks on Activity
P26	ENETO_PHY_TRXN1	I/O		Differential Pair Signals for External Transformer
P27	ENETO_PHY_TRXP1	I/O		
P28	GBE0_CTREF	NC		Center tap of network transformer for GBE 0
P29	ENETO_PHY_TRXN0	I/O		Differential Pair Signals for External Transformer
P30	ENETO_PHY_TRXP0	I/O		
P31	NC	-	-	No connection
P32	GND			Ground
P33	NC	-	-	No connection
P34	SD2_CMD	I/O	1.8V	SD Command Response
P35	SD2_nCD	I	1.8V	SD Card Detection
P36	SD2_CLK	O	1.8V	SD Clock
P37	SD2_PWR_EN	O	1.8V	SD Power Enabling
P38	GND			Ground
P39	SD2_DATA0	I/O	1.8V	SD Data Line
P40	SD2_DATA1	I/O	1.8V	SD Data Line
P41	SD2_DATA2	I/O	1.8V	SD Data Line
P42	SD2_DATA3	I/O	1.8V	SD Data Line
P43	ECSPI1_SS0	O	1.8V	SPI0 Master Chip Select 0
P44	ECSPI1_SCLK	O	1.8V	SPI0 Clock
P45	ECSPI1_MISO	I	1.8V	SPI0 Master input / Slave output
P46	ECSPI1_MOSI	O	1.8V	SPI0 Master output / Slave input
P47	GND	P		Ground
P48	NC	-	-	No connection
P49	NC	-	-	No connection
P50	NC	-	-	No connection
P51	NC	-	-	No connection
P52	NC	-	-	No connection
P53	NC	-	-	No connection
P54	SD3_CMD	O	1.8V	SPI1 Master Chip Select 0
P55	NC	-	-	No connection
P56	SD3_CLK	O	1.8V	SPI1 Clock
P57	SD3_DATA1	I	1.8V	SPI1 Master input / Slave output
P58	SD3_DATA0	O	1.8V	SPI1 Master output / Slave input
P59	GND	P	1.8V	Ground
P60	USB0_DP	I/O	USB	USB Differential Data Pairs for Port 0
P61	USB0_DN	I/O	USB	
P62	NC	-	-	No connection

Primary (Top) Side	Function	I/O	I/O Level	Description
P63	USB0_VBUS_DET	I	USB VBUS 5V	USB Port 0 Host Power Detection
P64	USB0_ID	I	3.3V	USB_OTG detection foot
P65	USB_HUB_D2+	I/O		USB Differential Data Pairs for Port 2
P66	USB_HUB_D2-	I/O		
P67	USB_H1_EN	I/O	3.3V (PU 100K)	USB1 ENABLE
P68	GND	p		Ground
P69	USB_HUB_D4+	I/O		USB Differential Data Pairs for Port 4
P70	USB_HUB_D4-	I/O		
P71	USB_H2_EN	I/O	3.3V (PU 100K)	USB2 ENABLE
P72	NC	-	-	No connection
P73	NC	-	-	No connection
P74	USB_H3_EN	I/O	3.3V (PU 100K)	USB3 ENABLE
P75	NC	-	-	No connection
P76	NC	-	-	No connection
P77	NC	-	-	No connection
P78	NC	-	-	No connection
P79	NC	-	-	No connection
P80	NC	-	-	No connection
P81	NC	-	-	No connection
P82	NC	-	-	No connection
P83	NC	-	-	No connection
P84	NC	-	-	No connection
P85	NC	-	-	No connection
P86	NC	-	-	No connection
P87	NC	-	-	No connection
P88	NC	-	-	No connection
P89	NC	-	-	No connection
P90	NC	-	-	No connection
P91	NC	-	-	No connection
P92	NC	-	-	No connection
P93	NC	-	-	No connection
P94	NC	-	-	No connection
P95	NC	-	-	No connection
P96	NC	-	-	No connection
P97	NC	-	-	No connection
P98	NC	-	-	No connection
P99	NC	-	-	No connection
P100	NC	-	-	No connection
P101	NC	-	-	No connection
P102	NC	-	-	No connection
P103	NC	-	-	No connection
P104	NC	-	-	No connection
P105	NC	-	-	No connection
P106	NC	-	-	No connection
P107	NC	-	-	No connection
P108	GPIO0/CAM0_PWR#	O	1.8V	GPIO
P109	GPIO2/CAM0_RST#	O	1.8V	GPIO

Primary (Top) Side	Function	I/O	I/O Level	Description
P110	NC	-	-	No connection
P111	NC	-	-	No connection
P112	NC	-	-	No connection
P113	NC	-	-	No connection
P114	NC	-	-	No connection
P115	NC	-	-	No connection
P116	S_GPIO10	I/O	1.8V	GPIO
P117	NC	-	-	No connection
P118	NC	-	-	No connection
P119	NC	-	-	No connection
P120	NC	-	-	No connection
P121	I2C1_PM_CL	O	1.8V	I2C clock for power management
P122	I2C1_PM_DATA	I/O	1.8V	I2C data for power management
P123	BOOT_SEL0#	I	1.8V	Boot Mode and CFG Switch
P124	BOOT_SEL1#	I	1.8V	Boot Mode and CFG Switch
P125	BOOT_SEL2#	I	1.8V	Boot Mode and CFG Switch
P126	NC	-	-	No connection
P127	RESET_IN#	I	1.8V	SYS RESET
P128	POWER_BTN#	I	1.8V	Power on/off
P129	UART2_TXD	O	1.8V	Asynchronous Serial Data Output Port 2
P130	UART2_RXD	I	1.8V	Asynchronous Serial Data Input Port 2
P131	NC	-	-	No connection
P132	NC	-	-	No connection
P133	NC	-	-	No connection
P134	UART1_TXD	O	1.8V	Asynchronous Serial Data Output Port 1
P135	UART1_RXD	I	1.8V	Asynchronous Serial Data Input Port 1
P136	UART3_TXD	O	1.8V	Asynchronous Serial Data Output Port 3
P137	UART3_RXD	I	1.8V	Asynchronous Serial Data Input Port 3
P138	UART3_RTS#	O	1.8V	Request to Send Handshake Line for Port 3
P139	UART3_CTS#	I	1.8V	Clear to Send Handshake Line for Port 3
P140	UART5_TXD	O	1.8V	Asynchronous Serial Data Output Port 5
P141	UART5_RXD	I	1.8V	Asynchronous Serial Data Input Port 5
P142	NC	-	-	No connection
P143	FLEXCAN1_TX	O	1.8V	CAN Port 0 Transmit Output
P144	FLEXCAN1_RX	I	1.8V	CAN Port 0 Receive Output
P145	FLEXCAN2_TX	O	1.8V	CAN Port 1 Transmit Output
P146	FLEXCAN2_RX	I	1.8V	CAN Port 1 Receive Output
P147	VDD_IN	P	5.0V	5V Power in
P148	VDD_IN	P	5.0V	5V Power in
P149	VDD_IN	P	5.0V	5V Power in
P150	VDD_IN	P	5.0V	5V Power in
P151	VDD_IN	P	5.0V	5V Power in
P152	VDD_IN	P	5.0V	5V Power in
P153	VDD_IN	P	5.0V	5V Power in
P154	VDD_IN	P	5.0V	5V Power in
P155	VDD_IN	P	5.0V	5V Power in
P156	VDD_IN	P	5.0V	5V Power in

Secondary (Bottom) Side	Function	I/O	I/O Level	Description
S1	NC	-	-	No connection
S2	NC	-	-	No connection
S3	GND	P		Ground
S4	I2S2_MCLK			I2S2_MCLK
S5	I2C3_CAM0_CK	O	1.8V (PU 2.2K)	I2C Clock
S6	CAM_MCK	O	1.8V	CCM_CLKOUT
S7	I2C3_CAM0_DAT	O	1.8V (PU 2.2K)	I2C Data
S8	NC	-	-	No connection
S9	NC	-	-	No connection
S10	GND	P		Ground
S11	NC	-	-	No connection
S12	NC	-	-	No connection
S13	GND	p		Ground
S14	NC	-	-	No connection
S15	NC	-	-	No connection
S16	GND	P		Ground
S17	ENET1_PHY_TRXN0	I/O		Differential Pair Signals for External Transformer
S18	ENET1_PHY_TRXP0	I/O		
S19	NC	-	-	No connection
S20	ENET1_PHY_TRXN1	I/O		Differential Pair Signals for External Transformer
S21	ENET1_PHY_TRXP1	I/O		
S22	ENET1_LED_LINK1000	O	3.3V	Link Speed Indication LED for ENET1 1000Mbps
S23	ENET1_PHY_TRXN2	I/O		Differential Pair Signals for External Transformer
S24	ENET1_PHY_TRXP2	I/O		
S25	GND	P		Ground
S26	ENET1_PHY_TRXN3	I/O		Differential Pair Signals for External Transformer
S27	ENET1_PHY_TRXP3	I/O		
S28	GBE1_CTREF	NC		Center tap of network transformer for GBE 1
S29	NC	-	-	No connection
S30	NC	-	-	No connection
S31	LED_ACT1	O	3.3V	Link / Activity Indication LED Driven Low on Link (10, 100 or 1000 Mbps) Blinks on Activity
S32	NC	-	-	No connection
S33	NC	-	-	No connection
S34	NC	-	-	No connection
S35	USB_HUB_D1+	I/O		USB Differential Data Pairs for Port 1
S36	USB_HUB_D1+	I/O		
S37	NC	-	-	No connection
S38	NC	-	-	No connection
S39	NC	-	-	No connection
S40	NC	-	-	No connection
S41	NC	-	-	No connection
S42	NC	-	-	No connection
S43	NC	-	-	No connection
S44	NC	-	-	No connection
S45	NC	-	-	No connection

Secondary (Bottom) Side	Function	I/O	I/O Level	Description
S46	NC	-	-	No connection
S47	NC	-	-	No connection
S48	I2C_GP_CK	O	1.8V (PU 2.2K)	I2C
S49	I2C_GP_DAT	I/O	1.8V (PU 2.2K)	I2C
S50	I2S2_LRCK	I/O	1.8V	I2S2 Left & Right Synchronization Clock
S51	I2S2_SDOOUT	O	1.8V	I2S2 Digital Audio Output
S52	I2S2_SDIN	I	1.8V	I2S2 Digital Audio Input
S53	I2S2_CK	I/O	1.8V	I2S2 Digital Audio Clock
S54	NC	-	-	No connection
S55	NC	-	-	No connection
S56	SD3_DATA2	I/O	1.8V	GPIO
S57	SD3_DATA3	I/O	1.8V	GPIO
S58	NC	-	-	No connection
S59	NC	-	-	No connection
S60	NC	-	-	No connection
S61	NC	-	-	No connection
S62	NC	-	-	No connection
S63	NC	-	-	No connection
S64	NC	-	-	No connection
S65	NC	-	-	No connection
S66	NC	-	-	No connection
S67	NC	-	-	No connection
S68	USB_DP_DN3	I/O	USB	USB Differential Data Pairs for Port 3
S69	USB_DM_DN3	I/O	USB	
S70	NC	-	-	No connection
S71	NC	-	-	No connection
S72	NC	-	-	No connection
S73	NC	-	-	No connection
S74	NC	-	-	No connection
S75	NC	-	-	No connection
S76	NC	-	-	No connection
S77	NC	-	-	No connection
S78	NC	-	-	No connection
S79	NC	-	-	No connection
S80	NC	-	-	No connection
S81	NC	-	-	No connection
S82	NC	-	-	No connection
S83	NC	-	-	No connection
S84	NC	-	-	No connection
S85	NC	-	-	No connection
S86	NC	-	-	No connection
S87	NC	-	-	No connection
S88	NC	-	-	No connection
S89	NC	-	-	No connection
S90	NC	-	-	No connection
S91	NC	-	-	No connection
S92	NC	-	-	No connection

Secondary (Bottom) Side	Function	I/O	I/O Level	Description
S93	NC	-	-	No connection
S94	NC	-	-	No connection
S95	NC	-	-	No connection
S96	NC	-	-	No connection
S97	NC	-	-	No connection
S98	NC	-	-	No connection
S99	NC	-	-	No connection
S100	NC	-	-	No connection
S101	NC	-	-	No connection
S102	NC	-	-	No connection
S103	NC	-	-	No connection
S104	NC	-	-	No connection
S105	NC	-	-	No connection
S106	NC	-	-	No connection
S107	LCD1_BKLT_EN	O	1.8V	GPIO
S108	NC	-	-	No connection
S109	NC	-	-	No connection
S110	GND			Ground
S111	NC	-	-	No connection
S112	NC	-	-	No connection
S113	NC	-	-	No connection
S114	NC	-	-	No connection
S115	NC	-	-	No connection
S116	LCD1_VDD_EN	O	1.8V	GPIO
S117	NC	-	-	No connection
S118	NC	-	-	No connection
S119	GND			Ground
S120	NC	-	-	No connection
S121	NC	-	-	No connection
S122	LCD1_BKLT_PWM	O	1.8V	GPIO
S123	S_GPIO13	I/O	1.8V	GPIO Pin 13 Preferred Input
S124	GND			Ground
S125	NC	-	-	No connection
S126	NC	-	-	No connection
S127	LCD0_BKLT_EN	O	1.8V	GPIO
S128	NC	-	-	No connection
S129	NC	-	-	No connection
S130	GND			Ground
S131	NC	-	-	No connection
S132	NC	-	-	No connection
S133	LCD0_VDD_EN	O	1.8V	GPIO
S134	NC	-	-	No connection
S135	NC	-	-	No connection
S136	GND			Ground
S137	NC	-	-	No connection
S138	NC	-	-	No connection
S139	I2C_LCD_CK	I/O	1.8V (PU 2.2K)	I2C Clock

Secondary (Bottom) Side	Function	I/O	I/O Level	Description
S140	I2C_LCD_DAT	I/O	1.8V (PU 2.2K)	I2C Data
S141	LCDO_BKLT_PWM	O	1.8V	GPIO
S142	S_GPIO12	I/O	1.8V	GPIO Pin 12 Preferred Input
S143	NC	-	-	No connection
S144	NC	-	-	No connection
S145	WDT_TIME_OUT	O	1.8V	Watchdog Output
S146	NC	-	-	No connection
S147	RTC_VBAT	P	3.3V	RTC POWER
S148	TAMPER0			Tamper-proof detection signal 0
S149	TAMPER1			Tamper-proof detection signal 1
S150	NC	-	-	No connection
S151	ADC_IN1	I		ADC_IN1
S152	ADC_IN2	I		ADC_IN2
S153	ADC_IN3	I		ADC_IN3
S154	NC	-	-	No connection
S155	NC	-	-	No connection
S156	USB_H4_EN	I/O	3.3V (PU 100K)	USB4 ENABLE
S157	NC	-	-	No connection
S158	NC	-	-	No connection

## Ordering Information

### Nomenclature

VT-SBC-SMARC-IMX91 - [Memory]

Memory: **Null**-512MB, **M2**-LPDDR4 2GB, **M8**-LPDDR4

Ordering No.	Operating System	Storage	Form Factor	Memory
VT-SBC-SMARC-IMX91	Linux	16GB	SMARC 2.1	512MB
VT-SBC-SMARC-IMX91-M2	Linux	16GB	SMARC 2.1	2GB
VT-SBC-SMARC-IMX91-M8	Linux	16GB	SMARC 2.1	8GB

Packing List	
VT-SBC-SMARC-IMX91 computer-on-module	1

Optional Accessory	
LPDDR4	2GB/8GB

Since its establishment in 2002 by two Silicon Valley entrepreneurs, Vantron Technology has been at the forefront of the connected IoT devices and IoT platform solutions. Today, Vantron boasts a global customer base that includes many Fortune Global 500 companies. Its product lines cover edge intelligent hardware, IoT communication devices, industrial displays and BlueSphere cloud platforms.

With over 20 years of experience in R&D of intelligent edge hardware, Vantron has provided users with diverse embedded solutions featuring ARM and X86 architectures. Its offerings range from Linux, Android to Windows, from embedded to desktop level, and from gateways to servers. In addition, it provides users with system trimming, driver transplantation and more to cater to the unique needs of its users.