

VOSM6490 System-on-Module



Product Brief









The VOSM6490 is a premium, ready-to-integrate System-on-Module designed to accelerate the development of next-generation, high-performance embedded IoT devices. The module delivers flagship-level computing, artificial intelligence, and connectivity within the compact and scalable OSM (Open Standard Module) form factor. Powered by the Qualcomm® processor, it integrates an octa-core Kryo™ 670 cluster running at up to 2.7 GHz, paired with an Adreno™ 643 GPU and a 12-TOPS Hexagon™ NPU, delivering sufficient raw performance for demanding edge AI workloads while keeping the module within a low-power envelope.

The VOSM6490 supports FHD+ video display, up to 64MP at 30fps camera ISP, alongside the internal Hexagon™ DSP for high-quality multimedia applications. Connectivity is enabled via the carrier board, supporting dual GbE ports, Wi-Fi, and Bluetooth. A comprehensive set of I/O is exposed through the standard OSM edge connector, including USB, PCIe, GPIO, multiple serial interfaces, and audio channels, enabling flexible, high-performance industrial and commercial IoT designs.

With support for Android 15+ and Linux distributions upon request, it offers developers a streamlined path, featuring extended software support and enhanced security from the outset. The VOSM6490 is ideally suited for a wide range of demanding applications, including HMI, machine vision systems, autonomous mobile robots, advanced digital signage, and patient monitoring devices.

Features and benefits

VOSM6490

-  High-performance, low-power edge AI processor
-  Up to 12 TOPS NPU for efficient real-time inference
-  2160p H.265/H.264 encoder & decoder
-  64MP@30fps ZSL camera ISP
-  Rich I/O: USB, UART, SPI, GPIO, PCIe, I2C, PWM
-  GbE, Wi-Fi, BT support via carrier board
-  Android and Linux systems supported
-  OSM size-L (45mm x 45mm) compliant
-  Extended service life (7+ years)

Application Scenarios



Smart Cities



Smart Retail



Surveillance System



Home Appliance



Industrial IoT



Healthcare

VOSM6490 System-on-Module Datasheet

Specifications			
System	CPU	Qualcomm QCS6490 octa-core Kryo 670 processor: 1 x A78@2.7GHz, 3 x A78@2.4GHz, 4 x A78@1.9GHz	
	GPU	Qualcomm Adreno 643 GPU, 812MHz, Support OpenGL ES 3.2, Vulkan 1.x, OpenCL 2.0, DX FL12	
	NPU	Qualcomm Hexagon 770 NPU, up to 12 Dense TOPS	
	Memory	8GB LPDDR5	
	Storage	64GB eMMC 5.1	
Media	Video processing	2160p@60 8-bit decoder for H.265/H.264/VP9	2160p@30 8-bit encoder for H.265/H.264
	Image signal processing	Qualcomm Spectra 570L ISP Single camera resolution: 64MP@30fps ZSL	
	Digital signal processing	Qualcomm Hexagon DSP, 1980 MPPS	
Power	Input	5V/3A DC input	
Software	Operating system	Android 15+, Linux support upon request	
	Device management	BlueSphere MDM (Optional for Android version)	
Mechanical	Dimensions	45mm x 45mm (OSM Size-L)	Packaging: LGA
Miscellaneous	RTC	Integrated RTC	
Environmental Condition	Temperature	Operating: -20°C ~ +60°C	Storage: -40°C ~ +80°C
	Humidity	5%~95% RH (Non-condensing)	

I/O			
UFS	1 x UFS 2.2 /UFS3.1, up to 512GB (with power supply)		
Display	1 x 4-Lane MIPI DSI D-PHY V1.2/C-PHY V1.0, up to 2520 x 1080 @144Hz		
	1 x 4-Lane eDP1.4, up to 2520 x 1080 @144Hz		
Camera	1 x 4-Lane MIPI CSI, up to 64MP@30fps ZSL		
Audio	2 x I ² S (support 1 x SDI, 1 x SDO)		
USB	1 x USB 3.1 Type-C, dual-role 5Gbps (non-DP ALT mode)		
	1 x USB 2.0 480Mbps, Host only		
PCIe	1 x 2-Lane PCIe 3.0 (Support NVMe SSD, PCIe Ethernet MAC)		
	1 x 1-Lane PCIe 3.0 (Support WLAN)		
SDIO	1 x 4-Bit SDIO V3.0		
ADC	2 x 10-Bit ADC input		
SPI	3 x SPI (Support 1 x MISO, 1 x MOSI)		
UART	1 x Debug UART (1.8V)	6 x Communication UART (1.8V)	
JTAG	Supported		
I ² C	3 x I ² C		
GPIO	32 x GPIO (Max.)		
PWM	5 x PWM		
Key Signal	1 x Power key	1 x Volume + key	
	1 x Reset/Volume - key	1 x Home key	
	1 x Force USB boot key	1 x 2-Bit boot select switch	

Product Outlines

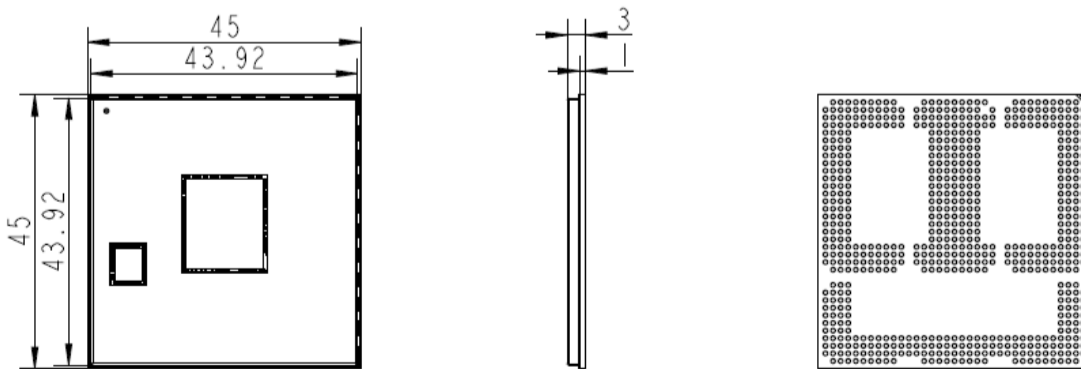

Block Diagram

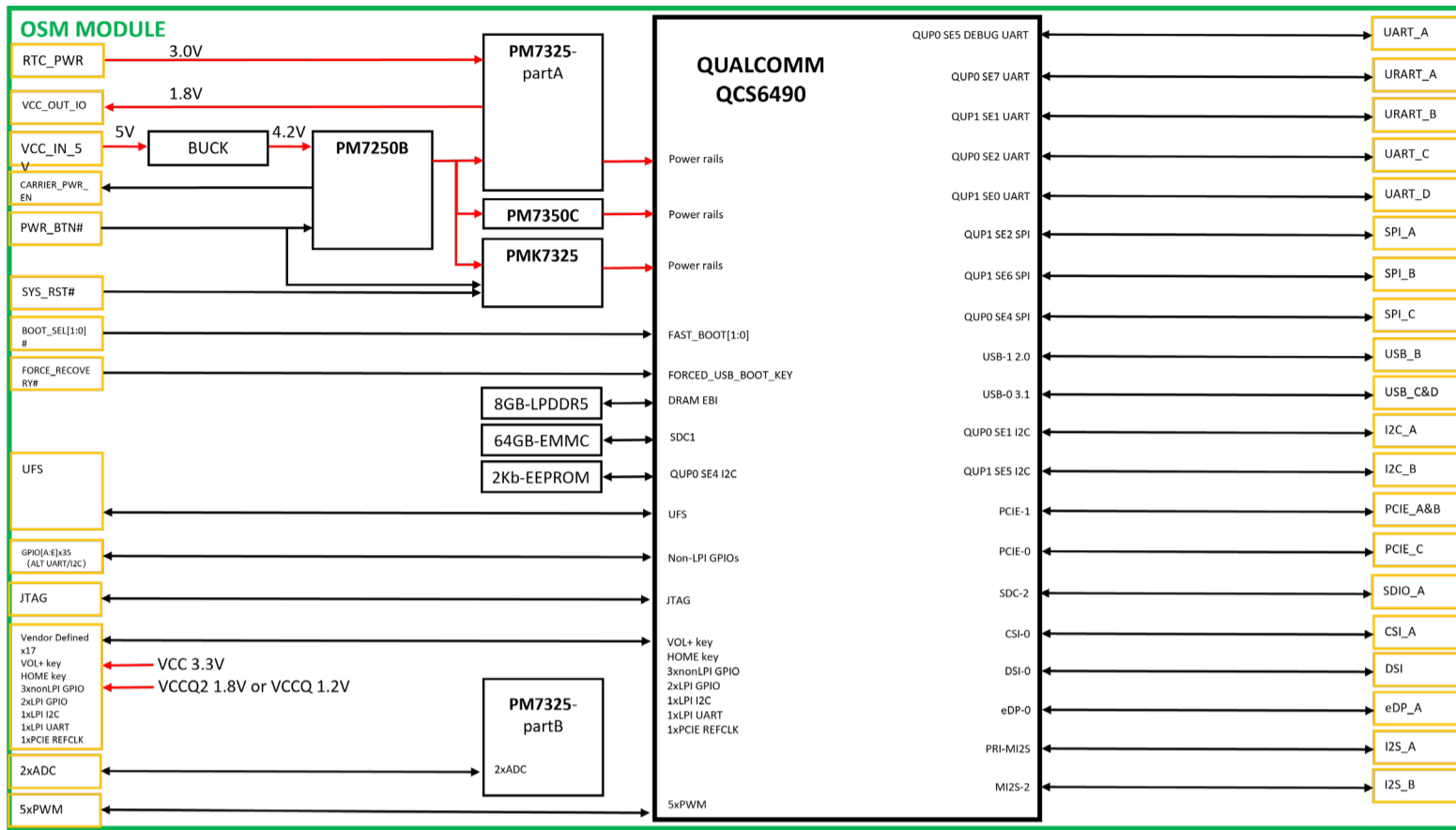

Electrical Characteristics

Absolute Maximum Ratings

Voltage beyond absolute maximum ratings may cause permanent damage to the module. Operation of the module outside of recommended conditions may result in reduced lifetime and/or reliability problems even if the absolute maximum ratings are not exceeded.

Parameter	Min.	Max.	Unit	
Voltage of the SOM Module (VCC_IN_5V)	-0.3	5.5	V	
Voltage of the RTC (SOM V_BAT)	-0.3	3.6	V	
Voltage of the Carrier (VCC_IO_OUT)	-0.3	1.85	V	
Voltage of LPDDR5 DRAM	LPDDR5 VDD1	-0.3	1.95	V
	LPDDR5 VDD2H	-0.3	1.12	V
	LPDDR5 VDD2L	-0.3	0.97	V
	LPDDR5 VDDQ	-0.3	0.55	V
VDD_APC (Kryo application processor)	APC0 (Silver)	-0.3	1.0472	V
	APC1 (Gold)	-0.3	1.2485	V
VDD_MODEM (Modem circuit)	-0.3	1.0472	V	
VDD_GFX (Graphics processor)	-0.3	0.9416	V	
VDD_PX1 (Pad group 1 - DDR pads)	-0.3	1.287	V	
VDD_PX2 (Pad group 2 - SDC2 pads)	-0.3	3.8984	V	
VDD_PX5 (Pad group 5 - UIM1 pads)	-0.3	3.63	V	
VDD_PX6 (Pad group 6 - UIM2 pads)	-0.3	3.63	V	
VDD_PX10 (Pad groups 10 - UFS pads)	-0.3	1.4344	V	
VDD_PX11 (Pad groups 11 - CXO pads)	-0.3	1.4344	V	
VDD_MX (On-chip memory)	-0.3	1.0472	V	
VDD_LPI_CX (LPI core)	-0.3	1.0428	V	

Parameter	Min.	Max.	Unit
VDD_A_USBSSDP_0_CORE (USB SS 0.9V circuit)	-0.3	1.0175	V
VDD_IO_EBIx (EBI I/O circuit)	-0.3	0.715	V
VDD_A_QREFS_1P25 (Reference voltage for QREFS 1.25V circuit)	-0.3	1.512	V
VDD_A_USBHS_3P1 (USB HS 3.1V circuit)	-0.3	3.8984	V
VDD_A_CXO_1P8 (1.8V for clock circuit)	-0.3	2.178	V
VDDPX_VBIAS_SDC (Bias voltage for SDC circuit)	-0.3	1.512	V
VDDPX_VBIAS_UIM (Bias voltage for UIM circuit)	-0.3	1.512	V
VDD_PX0 (Pad group 3 - control signal pads)	-0.3	2.2	V
VDD_PX3 (Pad group 3 - I/O pads)	-0.3	2.2	V
VDD_PX7 (Pad group 7 - SDC1 pads)	-0.3	2.2	V
VDD_CX (Digital core circuits)	-0.3	1.129	V
VDD_WPSS_CX (WPSS circuit)	-0.3	1.129	V
VDD_D_EBIx (EBI digital circuit)	-0.3	1.129	V
VDD_A_PCIE_0_1P2 (PCIe circuit)	-0.3	1.386	V
VDD_A_PCIE_1_1P2 (PCIe circuit)	-0.3	1.386	V
VDD_A_EDP_1P2 (eDP circuit)	-0.3	1.386	V
VDD_VREF_1P2 (PCIe QLink1 circuit)	-0.3	1.386	V
VDD_A_CSI_x_1P2 (CSI 1.2V circuit)	-0.3	1.386	V
VDD_A_UFS_0_1P2 (UFS 1.2V circuit)	-0.3	1.386	V
VDD_A_USBSSDP_0_1P2 (USB SS 1.2V circuit)	-0.3	1.386	V
VDD_A_QLINK_0_1P2_CK (QLink 0 clock circuit)	-0.3	1.386	V

(To be continued...)

Parameter	Min.	Max.	Unit
VDD_A_QLINK_1_1P2 (QLink 1 clock circuit)	-0.3	1.386	V
VDD_A_DSI_0_1P2 (DSI 1.2V circuit)	-0.3	1.386	V
VDD_A_PCIE_0_CORE (PCIe circuit)	-0.3	1.155	V
VDD_A_PCIE_1_CORE (PCIe circuit)	-0.3	1.155	V
VDD_A_EDP_0P9 (eDP circuit)	-0.3	1.155	V
VDD_VREF_0P9 (PCIe reference voltage)	-0.3	1.155	V
VDD_A_CSI_x_0P9 (CSIX 0.9V circuit)	-0.3	1.155	V
VDD_A_QLINK_x_0P9 (QLink 0.9V circuit)	-0.3	1.155	V
VDD_A_QLINK_x_0P9_CK (QLink clock circuit)	-0.3	1.155	V
VDD_A_UFS_0_CORE (UFS 0.9V circuit)	-0.3	1.155	V
VDD_A_USBHS_CORE (USB HS 0.9V circuit)	-0.3	1.155	V
VDD_A_GNSS_0P9 (GNSS circuit)	-0.3	1.155	V
VDD_A_DSI_0_0P9 (DSI 0.9V circuit)	-0.3	1.155	V
VDD_A_DSI_0_PLL_0P9 (DSI PLL 0.9V circuit)	-0.3	1.155	V
VDD_A_QREFS_0P875 (QREFS 0.875V circuit)	-0.3	1.155	V
VDD_A_EBIx (EBI PHY voltage circuit)	-0.3	1.155	V
VDD_A_PLL_EBIx (EBI PLL circuit)	-0.3	1.155	V
VDD_A_USBHS_1P8 (USB HS 1.8V circuit)	-0.3	2.178	V
VDD_QFPROM (Programming the QFPROM)	-0.3	2.178	V
VDD_A_GFX_CS_1P8 (GFX 1.8V circuit)	-0.3	2.178	V
VDD_A_TURNING_Q6_CS_1P8 (Q6 current sensor 1.8V circuit)	-0.3	2.178	V
VDD_A_QREFS_1P8 (QREFS 1.8V circuit)	-0.3	2.178	V
VDD_A_APC_CS_1P8 (Application processor current sensor 1.8V circuit)	-0.3	2.178	V
VDD_LPI_NAV_MX (LPI on chip memory – NAV)	-0.3	1.0043	V
VDD_LPI_MX (Low-power island memory circuit)	-0.3	1.0043	V
Operating temperature	Ambient = -30	Junction = +95	°C

Recommended Operating Conditions

You are recommended to operate the module in the following conditions to achieve optimized performance of the module.

Parameter	Min.	Typ.	Max.	Unit	
Voltage of the SOM Module (VCC_IN_5V)	4.8	5	5.2	V	
Voltage of the RTC (SOM V_BAT)	2.2	3	3.6	V	
Voltage of the Carrier (VCC_IO_OUT)	1.7	1.8	1.85	V	
Voltage of LPDDR5 DRAM	LPDDR5 VDD1	1.7	1.8	1.95	V
	LPDDR5 VDD2H	1.01	1.05	1.12	V
	LPDDR5 VDD2L	0.87	0.9	0.97	V
	LPDDR5 VDDQ	0.48	0.5	0.52	V
VDD_APC (Kryo application processor)	APC0 (Silver)	0.47	-	0.952	V
	APC1 (Gold)	0.484	-	1.135	V

Parameter	Min.	Typ.	Max.	Unit	
VDD_MODEM (Modem circuit)	0.47	-	0.952	V	
VDD_GFX (Graphics processor)	0.47	-	0.856	V	
VDD_PX1 (Pad group 1 - DDR pads)	1.01	1.05	1.12	V	
VDD_PX2 (Pad group 2 - SDC2 pads)	Low voltage	1.65	1.8	1.9	V
	High voltage	2.72	2.95	3.544	V
VDD_PX5 (Pad group 5 - UIM1 pads)	Low voltage	1.62	1.8	1.9	V
	High voltage	2.72	2.95	3.544	V
VDD_PX6 (Pad group 6 - UIM2 pads)	Low voltage	1.62	1.8	1.9	V
	High voltage	2.85	2.96	3.3	V
VDD_PX10 (Pad groups 10 - UFS pads)	1.1	1.2	1.304	V	
VDD_PX11 (Pad groups 11 - CXO pads)	1.1	1.2	1.304	V	
VDD_MX (On-chip memory)	0.695	-	0.952	V	
VDD_LPI_CX (LPI core)	0.47	-	0.948	V	
VDD_A_USBSSDP_0_CORE (USB SS 0.9V circuit)	0.825	0.875	0.925	V	
VDD_IO_EBIx (EBI I/O circuit)	0.47	0.5	0.57	V	
VDD_A_QREFS_1P25 (Reference voltage for QREFS 1.25V circuit)	1.125	1.25	1.375	V	
VDD_A_USBHS_3P1 (USB HS 3.1V circuit)	2.7	3.072	3.544	V	
VDD_A_CXO_1P8 (1.8V for clock circuit)	1.68	1.8	1.98	V	
VDDPX_VBIAS_SDC (Bias voltage for SDC circuit)	1.125	1.25	1.375	V	
VDDPX_VBIAS_UIM (Bias voltage for UIM circuit)	1.125	1.25	1.375	V	
VDD_PX0 (Pad group 3 - control signal pads)	1.68	1.8	2	V	
VDD_PX3 (Pad group 3 - I/O pads)	1.68	1.8	2	V	
VDD_PX7 (Pad group 7 - SDC1 pads)	1.68	1.8	2	V	
VDD_CX (Digital core circuits)	0.47	-	1.027	V	
VDD_WPSS_CX (WPSS circuit)	0.47	-	1.027	V	
VDD_D_EBIx (EBI digital circuit)	0.47	-	1.027	V	
VDD_A_PCIE_0_1P2 (PCIe circuit)	1.11	1.2	1.26	V	
VDD_A_PCIE_1_1P2 (PCIe circuit)	1.11	1.2	1.26	V	
VDD_A_EDP_1P2 (eDP circuit)	1.11	1.2	1.26	V	
VDD_VREF_1P2 (PCIe QLink1 circuit)	1.11	1.2	1.26	V	
VDD_A_CSI_x_1P2 (CSI 1.2V circuit)	1.11	1.2	1.26	V	
VDD_A_UFS_0_1P2 (UFS 1.2V circuit)	1.11	1.2	1.26	V	

(To be continued...)

Pinout

Parameter	Min.	Typ.	Max.	Unit
VDD_A_USBSSDP_0_1P2 (USB SS 1.2V circuit)	1.11	1.2	1.26	V
VDD_A_QLINK_0_1P2_CK (QLink 0 clock circuit)	1.11	1.2	1.26	V
VDD_A_QLINK_1_1P2 (QLink 1 clock circuit)	1.11	1.2	1.26	V
VDD_A_DSI_0_1P2 (DSI 1.2V circuit)	1.11	1.2	1.26	V
VDD_A_PCIE_0_CORE (PCIe circuit)	0.86	0.875	1.05	V
VDD_A_PCIE_1_CORE (PCIe circuit)	0.86	0.875	1.05	V
VDD_A_EDP_OP9 (eDP circuit)	0.86	0.875	1.05	V
VDD_VREF_OP9 (PCIe reference voltage)	0.86	0.875	1.05	V
VDD_A_CSI_x_OP9 (CSIX 0.9V circuit)	0.86	0.875	1.05	V
VDD_A_QLINK_x_OP9 (QLink 0.9V circuit)	0.86	0.875	1.05	V
VDD_A_QLINK_x_OP9_CK (QLink clock circuit)	0.86	0.875	1.05	V
VDD_A_UFS_0_CORE (UFS 0.9V circuit)	0.86	0.875	1.05	V
VDD_A_USBHS_CORE (USB HS 0.9V circuit)	0.86	0.875	1.05	V
VDD_A_GNSS_OP9 (GNSS circuit)	0.86	0.875	1.05	V
VDD_A_DSI_0_OP9 (DSI 0.9V circuit)	0.86	0.875	1.05	V
VDD_A_DSI_0_PLL_OP9 (DSI PLL 0.9V circuit)	0.86	0.875	1.05	V
VDD_A_QREFS_OP875 (QREFS 0.875V circuit)	0.86	0.875	1.05	V
VDD_A_EBix (EBI PHY voltage circuit)	0.64	-	1.014	V
VDD_A_PLL_EBix (EBI PLL circuit)	0.64	-	1.014	V
VDD_A_USBHS_1P8 (USB HS 1.8V circuit)	1.68	1.8	1.98	V
VDD_QFPROM (Programming the QFPROM)	1.68	1.8	1.98	V
VDD_A_GFX_CS_1P8 (GFX 1.8V circuit)	1.68	1.8	1.98	V
VDD_A_TURNING_Q6_CS_1P8 (Q6 current sensor 1.8V circuit)	1.68	1.8	1.98	V
VDD_A_QREFS_1P8 (QREFS 1.8V circuit)	1.68	1.8	1.98	V
VDD_A_APC_CS_1P8 (Application processor current sensor 1.8V circuit)	1.68	1.8	1.98	V
VDD_LPI_NAV_MX (LPI on chip memory – NAV)	0.695	-	0.913	V
VDD_LPI_MX (Low-power island memory circuit)	0.695	-	0.913	V

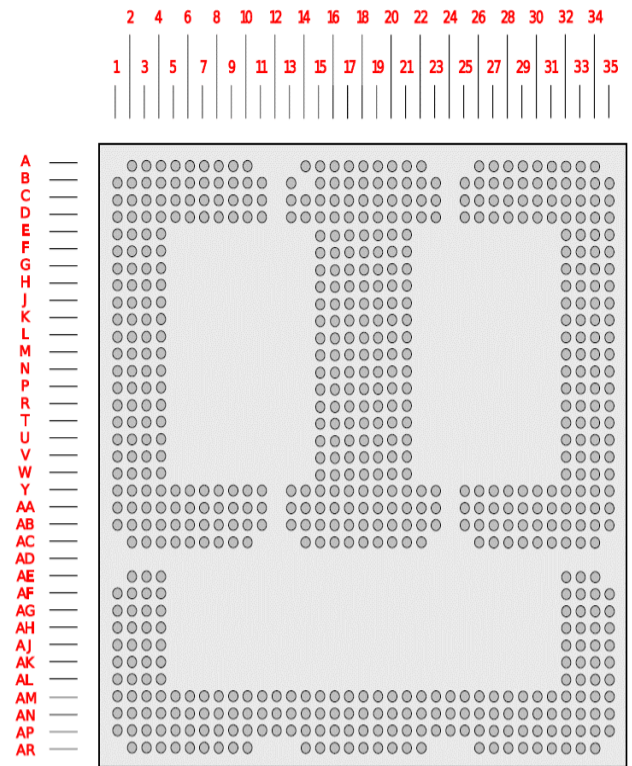

(View from top, through the module)

In the tables below:

- * **Pin** refers to the pin number defined by OSM as shown in above figure.
- * **Signal** refers to the pin name used by Vantron.
- * **CPU Pad Name** refers to corresponding pad name on the QCS6490 CPU.
- * Certain signals are derived from additional ICs and the corresponding IC names are provided.
- * Unless otherwise explicitly stated, the I/O level is 1.8V.

Pin*	Signal*	CPU Pad Name*	Description
U19	BOOT_SELO#	GPIO_120	BOOT config[0] BOOT config[1:0]=11=eMMC BOOT config[1:0]=10=UFS
R18	BOOT_SEL1#	GPIO_122	BOOT config[1] BOOT config[1:0]=11=eMMC BOOT config[1:0]=10=UFS
V17	CARRIER_PWR_EN	GPIO_02 (PM7250B)	Carrier power control 1=ON; 0=OFF (PD 1M)
T17	FORCE_RECOVERY#	GPIO_82	FORCED_USB_BOOT 0=boot from USB; 1=defined by BOOT config [1:0] (PU 10K)
AA9	PWR_BTN#	KPD_PWR_N (PM7250B, PMK7325)	POWER KEY 0=active; 1=inactive (PU 10K)
W17	RTC_PWR	VCOIN_1, VCOIN_2 (PM7250B)	RTC power input (3V voltage)
U17	SYS_RST#	RESIN_N (PMK7325)	RESET KEY 0=active; 1=inactive (PU 10K)
AB18, AA18	NC		No connection
M19, Y16, Y20, Y3, C5, AA33	NC		No connection
Y17, Y8, Y9	VCC_IN_5V		5V power input for the module

(To be continued...)

Pin	Signal	CPU Pad Name	Description
Y10, Y11, Y25, Y26, Y27, Y28, AE4	VCC_IN_5V		5V power input for the module
AF4, AG4, AH3, AH4, AJ3, AJ4, AK4	VCC_IN_5V		5V power input for the module
B29, Y19	NC		No connection
U18	VCC_OUT_IO	VREG_L18 (PM7325)	1.8V IO power source output < 100mA
D18, E15, E21, F16, F20, J16, J20, L18	GND		Ground
M16, M20, P18, R16, R20, V16	GND		Ground
V20, AA14, AA17, AA19, AA22, AB15	GND		Ground
Y18, AB21, A7, A10, A4, B2, B5, B8, B9	GND		Ground
C11, D1, D5, D8	GND		Ground
E2, H2, H4, L2, L4, P2, P4, R1, U2, U4	GND		Ground
V1, W3, Y2, AA1, AA4, AA7, AA8	GND		Ground
AA10, AA11, AB3, AB6, AB9, AC4, AC7	GND		Ground
AC10, A26, A29, A32, B27, B28, B30	GND		Ground
B33, C25, C32, C35	GND		Ground
D28, D34, F33, F35, G34, H32, J33	GND		Ground
J35, K34, M35, N34, T34, W34	GND		Ground
AA25, AA26, AE2	GND		Ground
AA27, AA28, AA32, AB28	GND		Ground
AB31, AB34, AC27, AC30, AC33, AE34	GND		Ground
AF35, AG3, AH2, AK3, AL2, AH34	GND		Ground
AJ35, AL34, AM13, AM16, AM19, AN3	GND		Ground
AM22, AM35, AN6	GND		Ground
AN9, AN11, AP2, AN15, AN18, AP5	GND		Ground
AN21, AN33, AP8, AP13, AP16, AP19	GND		Ground
AP22, AP25, AP28, AP31, AP34, AR14	GND		Ground
AR17, AR20, AR26, AR29, AR32, T18	GND		Ground
T19, Y13, Y14, N2, AA13, AA2, J32	NC		No connection
K32, K33, L32, M32, M33, N32, P32, P34	NC		No connection
R32, R33, T32, T33, AB25, AB26, AE32	NC		No connection
AL3, AL4, AM3, AM4, AM5, AM6, AM7, AM8	NC		No connection

Pin	Signal	CPU Pad Name	Description
AM9, AM10, AM23, AM24, AM25, AM26	NC		No connection
AM27, AM28, AM29, AM30, AM31, AN2	NC		No connection
AN5, AN7, AN8, AN24, AN25, AN26, AN27	NC		No connection
AN28, AN29, AN30	NC		No connection
AN31, AP10, AP22	NC		No connection
AP25, AP28, AP31, AP34, AR14	GND		Ground
AR17, AR20, AR26, AR29, AR32	GND		Ground
C2	MCLK of camera	CAM_MCLK0	Camera master clock
G3	PWN of camera	GPIO_136	Camera power enable
G4	RESET of camera	GPIO_20	Camera reset
B3	MIPI CSI 0 x 4 lanes (MPI CSI voltage)	CSIO_A0_CLK_M	MIPI CSI 0 differential clock -
B4		CSIO_NC_CLK_P	MIPI CSI 0 differential clock +
C1		CSIO_C0_LN0_M	MIPI CSI 0 differential data 0 -
B1		CSIO_B0_LN0_P	MIPI CSI 0 differential data 0 +
A2		CSIO_B1_LN1_M	MIPI CSI 0 differential data 1 -
A3		CSIO_A1_LN1_P	MIPI CSI 0 differential data 1 +
A5		CSIO_A2_LN2_M	MIPI CSI 0 differential data 2 -
A6		CSIO_C1_LN2_P	MIPI CSI 0 differential data 2 +
B6		CSIO_C2_LN3_M	MIPI CSI 0 differential data 3 -
B7		CSIO_B2_LN3_P	MIPI CSI 0 differential data 3 +
C4	I2C_CAM_SCL	CCI_I2C_SCL0	I2C serial clock
C3	I2C_CAM_SDA	CCI_I2C_SDA0	I2C serial data
F4	DISP_BL_EN	GPIO_2 (PM7350C)	Backlight enable for MIPI DSI display
E18	DISP_BL_PWM	GPIO_9 (PM7350C)	PWM dimming for MIPI DSI display
F3	DISP_VDD_EN	GPIO_44	VDD logic enable for MIPI DSI display
AB8	MIPI DSI 0 x 4 lanes (MPI DSI voltage)	DSIO_C1_CLK_M	MIPI DSI 0 clock -
AB7		DSIO_B1_CLK_P	MIPI DSI 0 clock +
AB11		DSIO_B0_LN0_M	MIPI DSI 0 differential data 0 -
AB10		DSIO_A0_LN0_P	MIPI DSI 0 differential data 0 +
AC9		DSIO_A1_LN1_M	MIPI DSI 0 differential data 1 -
AC8		DSIO_C0_LN1_P	MIPI DSI 0 differential data 1 +
AC6		DSIO_B2_LN2_M	MIPI DSI 0 differential data 2 -
AC5		DSIO_A2_LN2_P	MIPI DSI 0 differential data 2 +
AB5		DSIO_NC_LN3_M	MIPI DSI 0 differential data 3 -
AB4		DSIO_C2_LN3_P	MIPI DSI 0 differential data 3 +
AA3	DSI_TE	GPIO_80	Tearing effect (TE) of MIPI DSI display
M18	ADC_0	AMUX_2 (PM7325)	ADC input (8-bit recommended to use with NTC)
N18	ADC_1	AMUX_4 (PM7325)	ADC input (8-bit recommended to use with NTC)

(To be continued...)

Pin	Signal	CPU Pad Name	Description
AC18	JTAG_PS_HOLD	PS_HOLD (PMK7325)	JTAG power supply hold
R19	JTAG_TRST_N	JTAG_TRST_N	JTAG test reset, active low
P19	NC		No connection
N17	JTAG_TCK	JTAG_TCK	JTAG test clock
P17	JTAG_TDI	JTAG_TDI	JTAG test data in
R17	JTAG_TDO	JTAG_TDO	JTAG test data out
N19	JTAG_TMS	JTAG_TMS	JTAG test mode select
C18	NC		No connection
B22	KYPD_VOL_UP_N	GPIO_1 (PM7325)	Volume + key, active low
C16	KYPD_HOME_N	GPIO_3 (PM7250B)	Home key, active low
P16	I2S-B_MCLK	SEC_MI2S_MCLK	I2S master clock
D6	I2S-B_SCK	MI2S2_SCK	I2S serial clock
D7	I2S-B_LRCK	MI2S2_WS	I2S left-right clock
Y29	UFS_VCC_3.3V		3.3V power supply for UFS
Y30	UFS_VCCQ2_1.8V		1.8V power supply for UFS
Y31	UFS_VCCQ2_1.8V		1.8V power supply for UFS
AA29	UFS_VCC_3.3V		3.3V power supply for UFS
AA30	EXT_GPIO_1	GPIO_150	General-purpose 1.8V I/O
AA31	EXT_GPIO_2	GPIO_151	General-purpose 1.8V I/O
AK32	EXT_I2C_SDA	LPI_I2C_SDA	I2C serial data for external devices
AK33	EXT_I2C_SCL	LPI_I2C_SCL	I2C serial clock for external devices
AL32	EXT_UART_TX	LPI_UART_TX	UART transmit data
AL33	EXT_UART_RX	LPI_UART_RX	UART receive data
AM32	PCIE0_REFCLK_P_WCN	PCIE0_REFCLK_P	PCIe differential reference clock + for wireless module
AM33	PCIE0_REFCLK_M_WCN	PCIE0_REFCLK_M	PCIe differential reference clock - for wireless module
F18	PWM_1	GCC_GP1_CLK_MIRB	Pulse width modulation 1
G18	PWM_2	GCC_GP2_CLK_MIRB	Pulse width modulation 2
H18	PWM_3	GCC_GP3_CLK_MIRB	Pulse width modulation 3
J18	PWM_4	GCC_GP2_CLK_MIRA	Pulse width modulation 4
K18	PWM_5	GCC_GP3_CLK_MIRA	Pulse width modulation 5
AB17, AC17	NC		No connection
AB19, AC19	NC		No connection
C14	WCN_BT_UART_CTS	WCN_BT_UART_CTS	UART clear to send dedicated to BT
C13	WCN_BT_UART_RTS	WCN_BT_UART_RTS	UART request to send dedicated to BT
A14	WCN_BT_UART_RXD	WCN_BT_UART_RXD	UART receive data dedicated to BT
B13	WCN_BT_UART_TXD	WCN_BT_UART_TXD	UART transmit data dedicated to BT
D16	UART_B_CTS	UART_CTS (GPIO_36)	UART B clear to send
D15	UART_B_RTS	UART_RTS (GPIO_37)	UART B request to send
D14	UART_B_RXD	UART_RXD (GPIO_39)	UART B receive data
D13	UART_B_TXD	UART_TXD (GPIO_38)	UART B transmit data

Pin	Signal	CPU Pad Name	Description	
A22	UART_C_RXD	UART_RXD	UART C receive data	
B23	UART_C_TXD	UART_TXD	UART C transmit data	
D22	UART_DEBUG_RXD	UART_DEBUG_RXD	Debug UART receive data	
D23	UART_DEBUG_TXD	UART_DEBUG_TXD	Debug UART transmit data	
C22	UART_D_RXD	UART_RXD	UART D receive data	
C23	UART_D_TXD	UART_TXD	UART D transmit data	
V21	MI2S0_DATA0	MI2S0_DATA0	MI2S0 data 0	
W21	MI2S0_DATA1	MI2S0_DATA1	MI2S0 data 1	
V19	MI2S2_DATA0	MI2S2_DATA0	MI2S2 data 0	
W19	MI2S2_DATA1	MI2S2_DATA1	MI2S2 data 1	
W20	MI2S0_SCK	MI2S0_SCK	MI2S0 serial clock	
W18	MI2S0_WS	MI2S0_WS	MI2S0 word select	
V18	PRI_MI2S_MCLK	PRI_MI2S_MCLK	Primary MI2S master clock	
AB2	PCIe 1 lane 0 (PCIe voltage)	PCIE1_RX0_M	PCIe 1 receive data 0 -	
AB1		PCIE1_RX0_P	PCIe 1 receive data 0 +	
AC3		PCIE1_TX0_M	PCIe 1 transmit data 0 -	
AC2		PCIE1_TX0_P	PCIe 1 transmit data 0 +	
V2	PCIE1_RESET_N	PCIE1_RESET_N	PCIe 1 reset, active low	
M34	PCIe 1 lane 1 (PCIe voltage)	PCIE1_RX1_M	PCIe 1 receive data 1 -	
L34		PCIE1_RX1_P	PCIe 1 receive data 1 +	
L35		PCIE1_TX1_M	PCIe 1 transmit data 1 -	
K35		PCIE1_TX1_P	PCIe 1 transmit data 1 +	
L33, R2, T1, U1	NC		No connection	
W2	PCIE1_CLK_REQ_N	PCIE1_CLK_REQ_N	PCIe 1 clock request, active low	
Y1	PCIE1_REFCLK_M	PCIE1_REFCLK_M	PCIe 1 reference clock -	
W1	PCIE1_REFCLK_P	PCIE1_REFCLK_P	PCIe 1 reference clock +	
T2	PCIE1_WAKE_N	PCIE1_WAKE_N	PCIe 1 wakeup, active low	
D11	USB 0 HS (USB voltage)	USB0_HS_DM	USB 0 high-speed data -	
D10		USB0_HS_DP	USB 0 high-speed data +	
C10	USB-C VBUS EN	GPIO_1	USB-C VBUS enable	
D9	USB 0 SS (constant current)	CC1_ID (PM7250B)	USB 0 configuration channel 1	
C8		C2 (PM7250B)	USB 0 configuration channel 2	
B11		USB0_SS_RX0_M	USB 0 super-speed receive data 0 -	
B10		USB0_SS_RX0_P	USB 0 super-speed receive data 0 +	
A9		USB0_SS_TX0_M	USB 0 super-speed transmit data 0 -	
A8		USB0_SS_TX0_P	USB 0 super-speed transmit data 0 +	
C9		USB-C VBUS DET	GPIO_0	USB-C VBUS detection (5V)
D26, D25, C26, D27		NC		No connection
C28, B26, B25, A28	NC		No connection	
A27, C27, AB13	NC		No connection	
AA15	APPS_I2C_SCL	I2C_SCL	I2C serial clock for application processor	
AA16	APPS_I2C_SDA	I2C_SDA	I2C serial data for application processor	
AA20	I2C_SCL_TP	I2C_SCL	I2C serial clock for TP	
AA21	I2C_SDA_TP	I2C_SDA	I2C serial data for TP	

(To be continued...)

Pin	Signal	CPU Pad Name	Description
AC14, AC16, AB14 AB16, AC21	NC		No connection
AB23	USB 1 HS	USB1_HS_DM	USB 1 high-speed data -
AC22	(USB voltage)	USB1_HS_DP	USB 1 high-speed data +
AC20	USB_B_EN	GPIO_4 (PM7325)	USB-B enable
AB22	USB_B_ID	GPIO_62	USB-B OTG ID
AB20	USB_B_VBUS	GPIO_9 (PM7325)	USB-B VBUS (5V) (PD 47K)
J21	SD_CARD_DET_N	GPIO91	SD card detection (PU 10K)
F21	SDC2_CLK	SDC2_CLK	SDC 2 clock
E20	SDC2_CMD	SDC2_CMD	SDC 2 command (PU 10K)
G20	SDC2_DATA_0	SDC2_DATA_0	SDC 2 data bit 0
G21	SDC2_DATA_1	SDC2_DATA_1	SDC 2 data bit 1
H20	SDC2_DATA_2	SDC2_DATA_2	SDC 2 data bit 2
H21	SDC2_DATA_3	SDC2_DATA_3	SDC 2 data bit 3
C20	SDC2_VDDIO_3V/1.8V	VREG_L6 (PM7350C)	SDC 2 VDDIO (3V/1.8V)
D21	VREG_L9C_2P96	VREG_L9 (PM7350C)	Voltage regulator (3V) (PU 1K)
D20	SDC2_WP		SDC 2 write protection (PU 10K)
T21, K20, K21, L20, L21, M21	NC		No connection
N20, N21, P20, P21, R21, T20	NC		No connection
U21, U20, AC15	NC		No connection
D17	GPIO/LT8711_RESET	SM_GPIO_95	GPIO/defined on carrier
E17	GPIO/QPS615_1.8V_EN	SM_GPIO_68	GPIO/defined on carrier
F17	GPIO/QPS615_0.9V_EN	SM_GPIO_18	GPIO/defined on carrier
G17	GPIO/QPS615_RESET	SM_GPIO_19	GPIO/defined on carrier
H17	GPIO/QPS615_INT	SM_GPIO_21	GPIO/defined on carrier
J17	GPIO/UPD7202_RESET	SM_GPIO_141	GPIO/defined on carrier
D19	GPIO/RS485-1_UART_CTS	SM_GPIO_24	GPIO/defined on carrier
E19	GPIO/RS485-1_UART_RTS	SM_GPIO_25	GPIO/defined on carrier
F19	GPIO/RS485-1_UART_TX	SM_GPIO_26	GPIO/defined on carrier
G19	GPIO/RS485-1_UART_RX	SM_GPIO_27	GPIO/defined on carrier
H19	GPIO/TP_RESET	SM_GPIO_7	GPIO/defined on carrier
J19	GPIO/TP_INT	SM_GPIO_8	GPIO/defined on carrier
K19	GPIO/SPI to CAN-1 INT	SM_GPIO_142	GPIO/defined on carrier
L19	GPIO/SPI to CAN-1 SOP	SM_GPIO_46	GPIO/defined on carrier
D3	GPIO/M2-M_POWER_EN	SM_GPIO_47	GPIO/defined on carrier
D4	GPIO/FAN_EN	SM_GPIO_54	GPIO/defined on carrier
E3	GPIO/CAMERA_POWER_ON	SM_GPIO_55	GPIO/defined on carrier
E4	GPIO/eDP_BLK_EN	SM_GPIO_61	GPIO/defined on carrier
U32	GPIO/SPI to CAN-2 INT	SM_GPIO_84	GPIO/defined on carrier
U33	GPIO/SPI to CAN-2 SOP	SM_GPIO_85	GPIO/defined on carrier
V32	GPIO/WIFI_WAKE_AP	SM_GPIO_86	GPIO/defined on carrier
V33	GPIO/M2-E_POWER_EN	SM_GPIO_90	GPIO/defined on carrier
W32	GPIO/PCIE0_WAKE_N_WCN	SM_GPIO_89	GPIO/defined on carrier (PU 10K)
W33	GPIO/PCIE0_CLK_REQ_N_WCN	SM_GPIO_88	GPIO/defined on carrier (PU 10K)

Pin	Signal	CPU Pad Name	Description
Y32	GPIO/WLAN_DISABLE1	SM_GPIO_121	GPIO/definition on carrier
AF32	GPIO/WLAN_DISABLE2	SM_GPIO_125	GPIO/definition on carrier
AF33	GPIO/BT_WAKE_AP	SM_GPIO_127	GPIO/definition on carrier
AG32	GPIO/AP_WAKE_BT	SM_GPIO_129	GPIO/definition on carrier
AG33	GPIO/AUDIO_AMP_EN	SM_GPIO_75	GPIO/definition on carrier
AH32	GPIO/EXT_GPIO_3	SM_GPIO_119	GPIO/definition on carrier
AH33	GPIO/EXT_GPIO_4	SM_GPIO_123	GPIO/definition on carrier
AJ32	GPIO/EXT_I2C2_SDA	SM_GPIO_12	GPIO/definition on carrier
AJ33	GPIO/EXT_I2C2_SCL	SM_GPIO_13	GPIO/definition on carrier
W15, W16, K17	NC		No connection
Y15	SPI_A_CS0#	SM_GPIO_43	SPI_A chip select, active low
U16	SPI_A_SCK	SM_GPIO_42	SPI_A serial clock
U15	SPI_A_SDI	SM_GPIO_40	SPI_A serial data in
V15	SPI_A_SDO	SM_GPIO_41	SPI_A serial data out
AA23	SPI_B_CS0#	SM_GPIO_59	SPI_B chip select, active low
L17, Y33, F15, E16	NC		No connection
Y21	SPI_B_SCK	SM_GPIO_58	SPI_B serial clock
Y22	SPI_B_SDI	SM_GPIO_56	SPI_B serial data in
Y23	SPI_B_SDO	SM_GPIO_57	SPI_B serial data out
C30	SPI_C_CS0#	SM_GPIO_51	SPI_C chip select, active low
D29	SPI_C_SCK	SM_GPIO_50	SPI_C serial clock
C29	SPI_C_SDI	SM_GPIO_48	SPI_C serial data in
D30	SPI_C_SDO	SM_GPIO_49	SPI_C serial data out
F15, E16, R15, M15	NC		No connection
L16, N15, P15, J15	NC		No connection
K16, K15, L15, H15	NC		No connection
G15, H16, G16, N16	NC		No connection
E1, D2, P1, L1, K2	NC		No connection
M1, N1, H1, J2, J1	NC		No connection
K1, G1, F1, G2, F2	NC		No connection
C6, C7, M2, AB35	NC		No connection
AC34, W35, T35	NC		No connection
U34, R35, P35, N35	NC		No connection
V34, V35, U35	NC		No connection
Y35, AA35, Y34	NC		No connection
AA34, R34, N33	NC		No connection
P33, AF3, AE3, AP1	NC		No connection
AL1, AK2, AM1	NC		No connection
AN1, AH1, AJ2, AJ1	NC		No connection
AK1, AF1, AG1, AG2	NC		No connection
AF2, AM2, AR2	NC		No connection
AN4, AN10, AR8	NC		No connection
AR9, AR10, AR5	NC		No connection
AP6, AP3, AP4, AR6	NC		No connection
AR7, AR3, AR4, AP9	NC		No connection
M17, T16, T15	NC		No connection

(To be continued...)

Pin	Signal	CPU Pad Name	Description
AP32	PCIe 0 receive pair (PCIe voltage)	PCIE0_RX_M_WCN	PCIe 0 receive data - for wireless module
AP33		PCIE0_RX_P_WCN	PCIe 0 receive data + for wireless module
AP35, AN35, AL35	NC		No connection
AK35, AH35, AG35	NC		No connection
AR33	PCIe 0 transmit pair (PCIe voltage)	PCIE0_TX_M_WCN	PCIe 0 transmit data - for wireless module
AR34		PCIE0_TX_P_WCN	PCIe 0 transmit data + for wireless module
AC26	UFS_CLK	UFS0_REFCLK	UFS reference clock (1.2V~1.8V)
AB27	UFS_RESET#	UFS0_RESET_N	UFS reset, active low (1.2V~1.8V)
AC32	UFS receive and transmit lanes (UFS voltage)	UFS_RX0_N	UFS receive lane 0 -
AC31		UFS_RX0_P	UFS receive lane 0 +
AB33		UFS_RX1_N	UFS receive lane 1 -
AB32		UFS_RX1_P	UFS receive lane 1 +
AC29		UFS_TX0_N	UFS transmit lane 0 -
AC28		UFS_TX0_P	UFS transmit lane 0 +
AB30		UFS_TX1_N	UFS transmit lane 1 -
AB29		UFS_TX1_P	UFS transmit lane 1 +

Pin	Signal	CPU Pad Name	Description	
C34	EDPO_AUX_M	EDPO_AUX_M	eDP 0 auxiliary channel - (PU 100K)	
C33	EDPO_AUX_P	EDPO_AUX_P	eDP 0 auxiliary channel + (PD 100K)	
D32	eDP_A_VDD_EN	GPIO_4 (PM7350C)	eDP A VDD enable (PD 1M)	
D31	eDP_A_BL_EN	GPIO_7 (PM7350C)	eDP A backlight enable (PD 1M)	
D33	eDP_A_BL_HPD	eDP_HPD	eDP A backlight hot-plug detection (PD 1M)	
C31	eDP_A_BL_PWM	GPIO_9 (PM7350C)	eDP A backlight PWM control	
A31	eDP 0 transmit x 4 lanes (eDP HBR2/3 voltage)	EDPO_TX0_M	eDP 0 transmit lane 0 -	
A30		EDPO_TX0_P	eDP 0 transmit lane 0 +	
B32		EDPO_TX1_M	eDP 0 transmit lane 1 -	
B31		EDPO_TX1_P	eDP 0 transmit lane 1 +	
A34		EDPO_TX2_M	eDP 0 transmit lane 2 -	
A33		EDPO_TX2_P	eDP 0 transmit lane 2 +	
B35		EDPO_TX3_M	eDP 0 transmit lane 3 -	
B34		EDPO_TX3_P	eDP 0 transmit lane 3 +	
A20, C21, C19, C17		NC		No connection
A15, A17, A18, A19		NC		No connection
A21, B15, B16, B17	NC		No connection	
B18, B19, B21, A16	NC		No connection	

* Apart from those specified here, any pins not included in these sheets are not connected.

Ordering Information

Ordering No.	Memory	Storage	Connectivity	Description
VOSM6490	8GB LPDDR5	64GB eMMC	NA	MIPI DSI, eDP, MIPI CSI, SPI, PCIe, UART, USB, I ² C, GPIO
VT-SBC-VOSM6490-EVB	8GB LPDDR5	64GB eMMC 64GB/128GB UFS	GbE, Wi-Fi, Bluetooth	VOSM6490 + Carrier board, MIPI DSI/HDMI/eDP, UART, MIPI CSI, USB, GPIO

Packing List	
VOSM6490 system-on-module	1

Company Profile

Since its establishment in 2002 by two Silicon Valley entrepreneurs, Vantron Technology has been at the forefront of the connected IoT devices and IoT platform solutions. Today, Vantron boasts a global customer base that includes many Fortune Global 500 companies. Its product lines cover edge intelligent hardware, IoT communication devices, industrial displays and BlueSphere cloud platforms.

With over 20 years of experience in R&D of embedded edge intelligent hardware, Vantron has provided users with diverse embedded solutions featuring ARM and X86 architectures. Its offerings range from Linux to Windows, from embedded to desktop level, and from gateway to server. In addition, it provides users with system trimming, driver transplantation and more to cater to the unique needs of its users.